

1

2

3

4

5

6

A

A

B

B

C

C

D

D

1

2

3

4

5

6

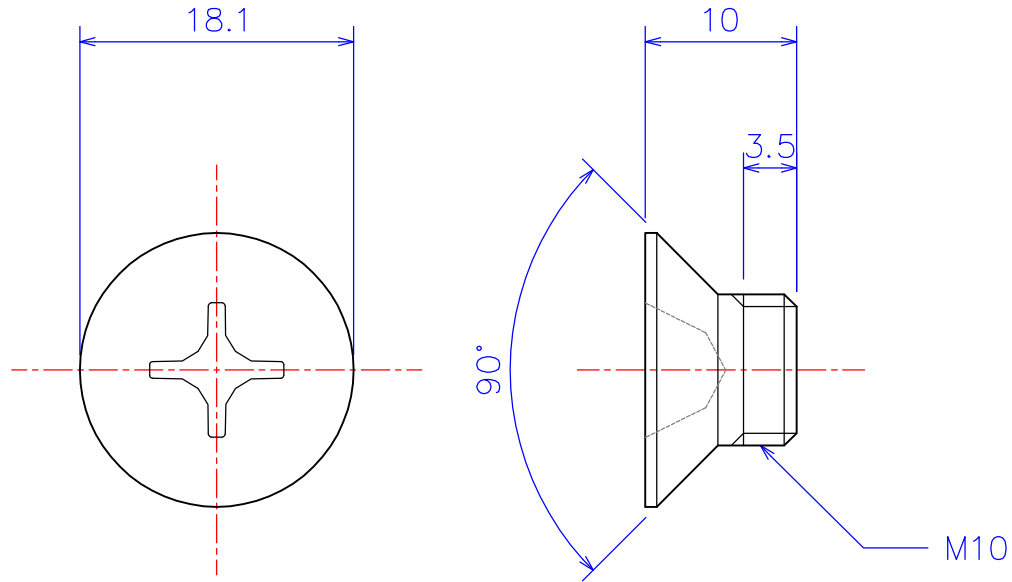

Method		Model ID / Item	ASM10-10 Flat Head Screw M10x10L Alumina Al <sub>2</sub> O <sub>3</sub>
Scale	2 : 1 (A4)	Model ID / Item	
Drawn	W.O. 2011.03.02		
		<b>KDA Corporation</b> 4-13-6 Nakarokugo Ohta-ku TOKYO 144-0055 JAPAN	