

1

2

3

4

5

6

A

A

B

B

C

C

D

D

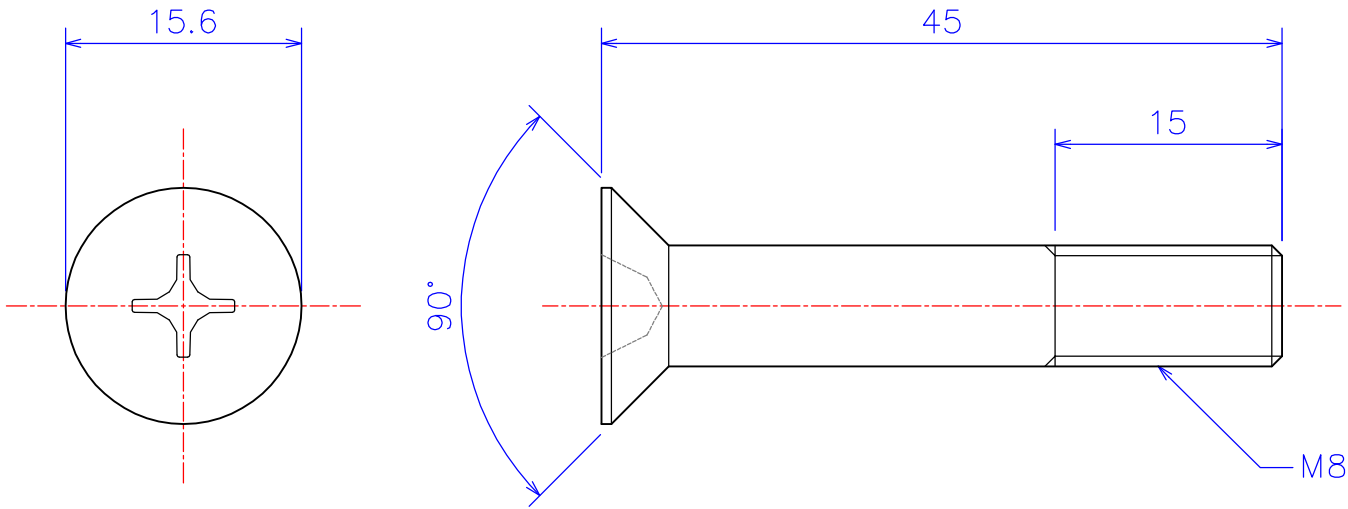

Method		Model ID / Item	ASM08-45 Flat Head Screw M8x45L Alumina Al ₂ O ₃
Scale	2 : 1 (A4)	Model ID / Item	
Drawn	W.O. 2011.03.02		
		KDA Corporation 4-13-6 Nakarokugo Ohta-ku TOKYO 144-0055 JAPAN	

1

2

3

4

5

6