

1

2

3

4

5

6

A

A

B

B

C

C

D

D

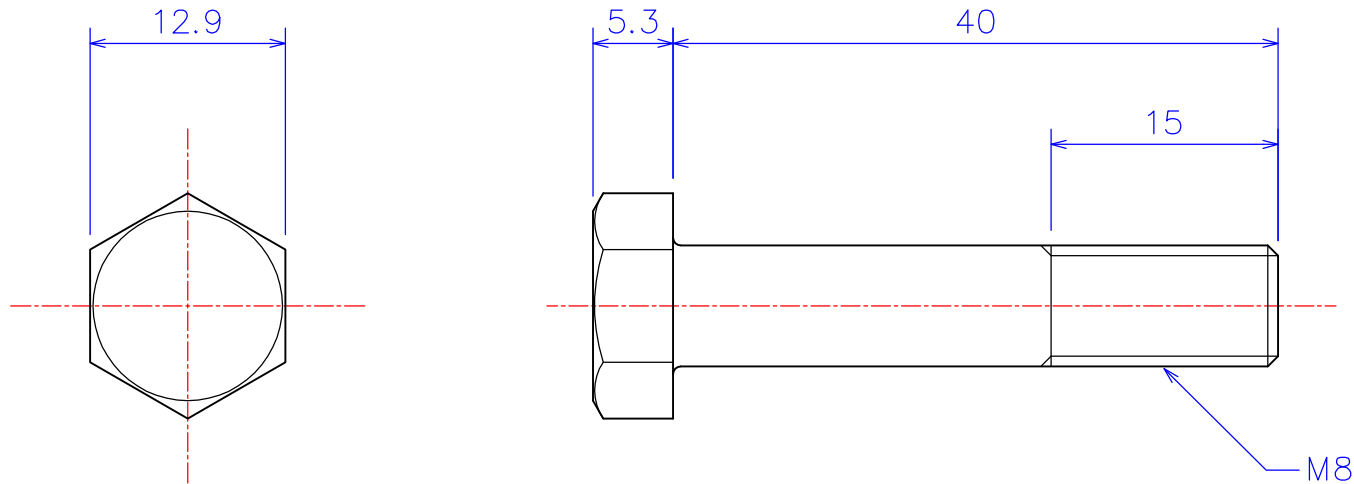

Method 	Model ID / Item ARM08-40 Hexagon Head Screw [Bolt] M8x40L Alumina Al ₂ O ₃
Scale 2 : 1 (A4)	Model ID / Item
Drawn W.O. 2011.03.02	
	KDA Corporation 4-13-6 Nakarokugo Ohta-ku TOKYO 144-0055 JAPAN

1

2

3

4

5

6