

1

2

3

4

5

6

A

A

B

B

C

C

D

D

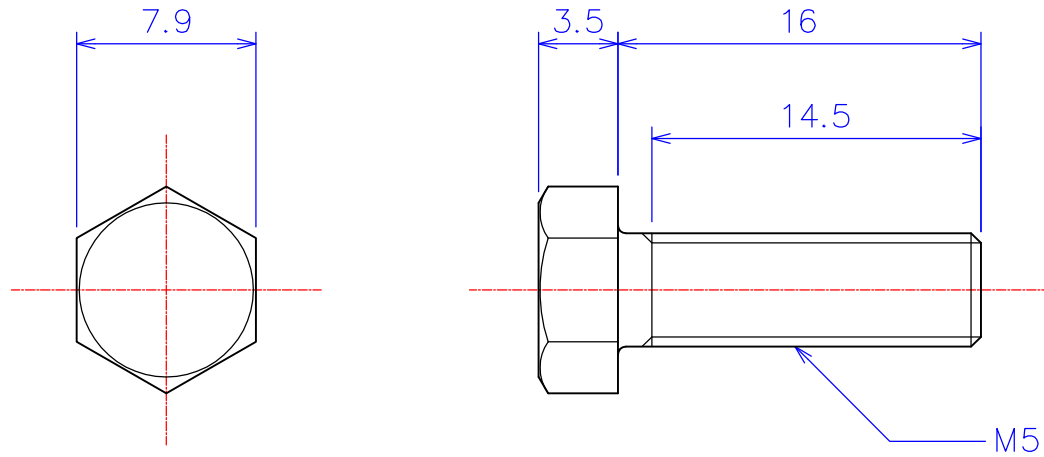

Method		Model ID / Item	ARM05-16	Hexagon Head Screw [Bolt] M5x16L Alumina Al <sub>2</sub> O <sub>3</sub>
Scale	3 : 1 (A4)	Model ID / Item	ZRM05-16	Hexagon Head Screw [Bolt] M5x16L Zirconia ZrO <sub>2</sub>
Drawn	W.O. 2011.03.01			
		<b>KDA Corporation</b>		
		4-13-6 Nakarokugo Ohta-ku TOKYO 144-0055 JAPAN		

1

2

3

4

5

6