

1

2

3

4

5

6

A

A

B

B

C

C

D

D

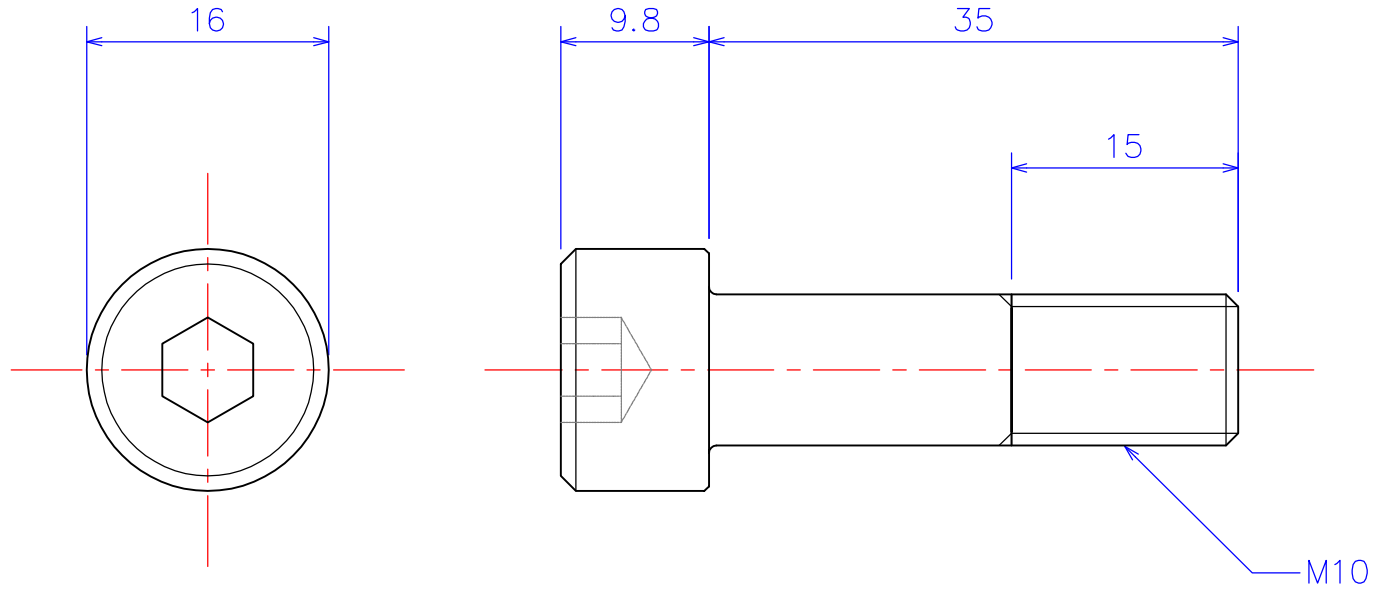

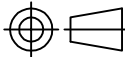
Method		Model ID / Item	ARAM10-35 Hexagon Socket Head Screw M10x35L Alumina Al ₂ O ₃
Scale	2 : 1 (A4)	Model ID / Item	
Drawn	W.O. 2011.03.02		

KDA Corporation

4-13-6 Nakarokugo Ohta-ku TOKYO 144-0055 JAPAN

1

2

3

4

5

6