

1

2

3

4

5

6

A

A

B

B

C

C

D

D

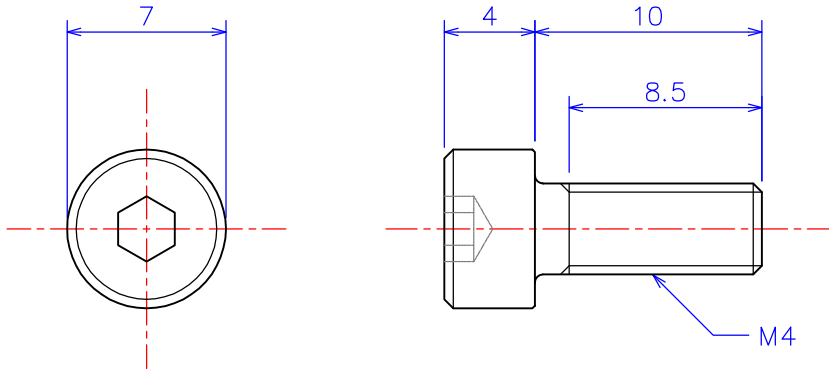

Method		Model ID / Item	ARAM04-10 Hexagon Socket Head Screw M4x10L Alumina Al ₂ O ₃
Scale	3 : 1 (A4)	Model ID / Item	ZRAM04-10 Hexagon Socket Head Screw M4x10L Zirconia ZrO ₂
Drawn	W.O. 2011.03.01		
		KDA Corporation	
		4-13-6 Nakarokugo Ohta-ku TOKYO 144-0055 JAPAN	

1

2

3

4

5

6