

1

2

3

4

5

6

A

A

B

B

C

C

D

D

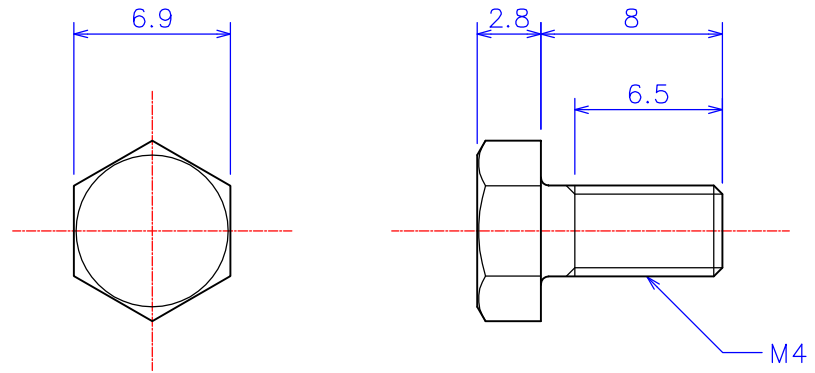

Method		Model ID / Item	ARM04-08	Hexagon Head Screw [Bolt] M4x8L Alumina Al ₂ O ₃
Scale	3 : 1 (A4)	Model ID / Item	ZRM04-08	Hexagon Head Screw [Bolt] M4x8L Zirconia ZrO ₂
Drawn	W.O. 2011.03.01			
		KDA Corporation		
		4-13-6 Nakarokugo Ohta-ku TOKYO 144-0055 JAPAN		

1

2

3

4

5

6