

1

2

3

4

5

6

A

A

B

B

C

C

D

D

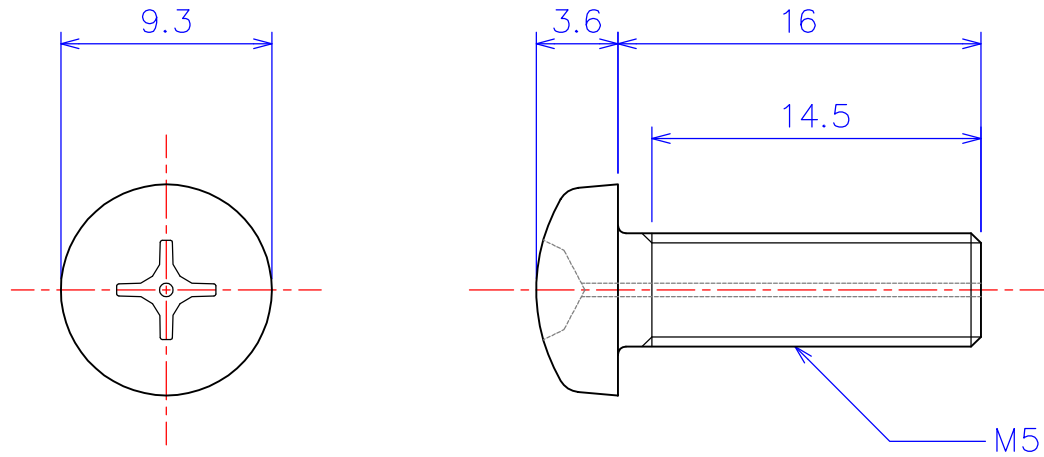

\* Notes: Products' hole diameter and the position are rough.

Method		Model ID / Item	ANSHM05-16	Pan Head gas hole Screw M5x16L Alumina Al <sub>2</sub> O <sub>3</sub>
Scale	3 : 1 (A4)	Model ID / Item	ZNSHM05-16	Pan Head gas hole Screw M5x16L Zirconia ZrO <sub>2</sub>
Drawn	W.O. 2011.11.17	<p><b>KDA Corporation</b> 4-13-6 Nakarokugo Ohta-ku TOKYO 144-0055 JAPAN</p>		

1

2

3

4

5

6