

1

2

3

4

5

6

A

A

B

B

C

C

D

D

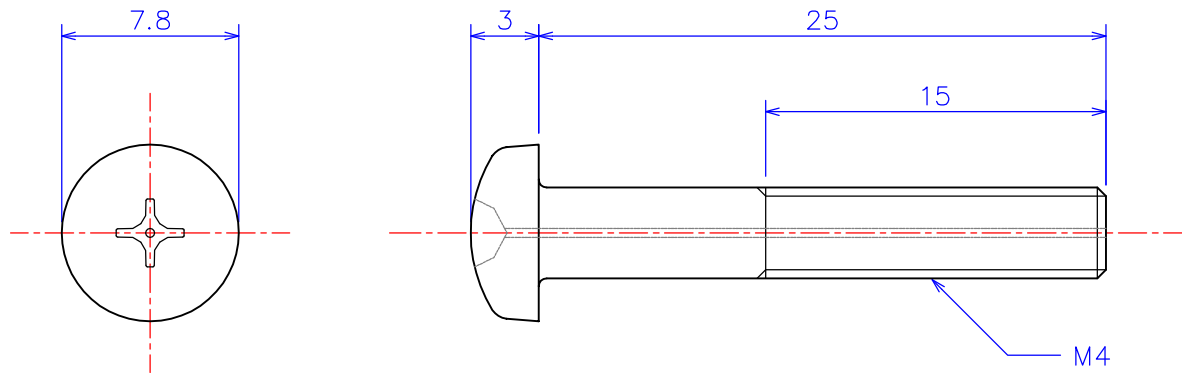

* Notes: Products' hole diameter and the position are rough.

Method		Model ID / Item	ANSHM04-25	Pan Head gas hole Screw M4x25L Alumina Al ₂ O ₃
Scale	3 : 1 (A4)	Model ID / Item	ZNSHM04-25	Pan Head gas hole Screw M4x25L Zirconia ZrO ₂
Drawn	W.O. 2011.11.17	<p>KDA Corporation 4-13-6 Nakarokugo Ohta-ku TOKYO 144-0055 JAPAN</p>		

1

2

3

4

5

6